



Feature:



Certificates:



Feature: >>>

- Aluminum housing in black / customized color
- Clear / milky / frosted / mirror PC cover
- Cable come out from bottom / side
- IP65

- Standard DMX 512 control, max 44frames/second
- 1led/pix, 2led/pix, 3led/pixl, 6led/pix or customized
- manual or auto address setting
- Hot plug

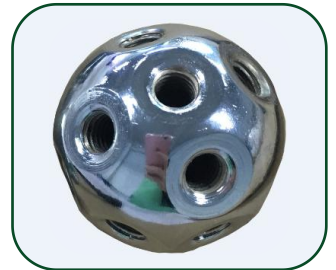

Product size and Parameters

DMX magic digital bar Unit: mm

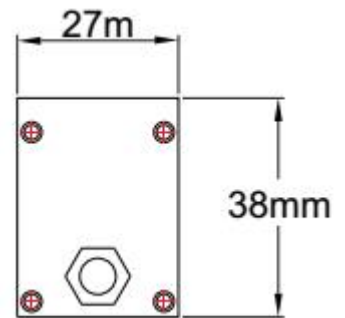
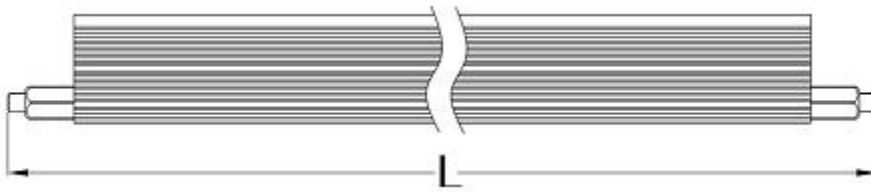

0.5m Magic Digital Bar	1m Magic Digital Bar	1.5m Magic Digital Bar
L=565mm	L=1065mm	L=1565mm

PRODUCT SPECIFICATION

Model NO.	LED-MB2738DMX1608	LED-MB2738DMX3216	LED-MB2738DMX4824
Dimension	565x27x38mm	1065x27x38mm	1565x27x38mm
LED type and QTY	16 pcs SMD RGB 5050	32 pcs SMD RGB 5050	48 pcs SMD RGB 5050
Pixel QTY	8 PIX	16 PIX	24 PIX
Emitting angle	120 degree	120 degree	120 degree
Color	RGB full color	RGB full color	RGB full color
Operating Voltage	DC 12V	DC 12V	DC 12V
Power	MAX=6W	MAX=12W	MAX=18W
Control Protocol	DMX512		
Address Setting	Automatically / Manually		
Control Mode	DMX Artnet / DMX DVI / Standalone Control		
Material	Aluminum housing + PC cover		
Housing Color	Black or customized color		
Cover Color	Clear / milky / frosted / mirror cover		
Protection	IP65		
LED Source Life	50,000 hours, based on test data of LED manufacturer		
Temperature	-4°F to 122°F (-20°C to 50°C) operating temperature		
Humidity Range	0 to 95% non-condensing		

Remark: Specifications are subject to change without notice.

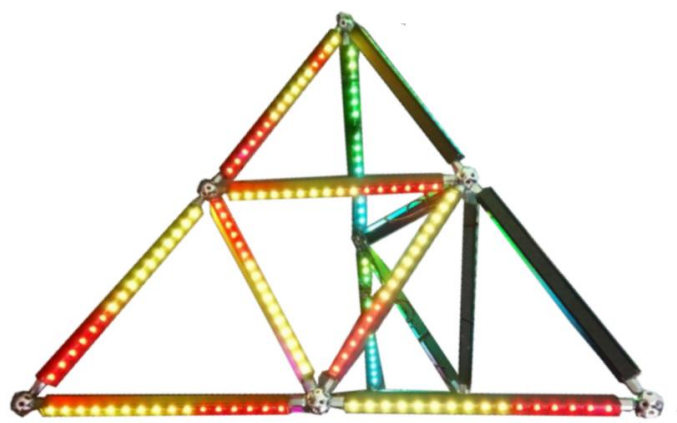
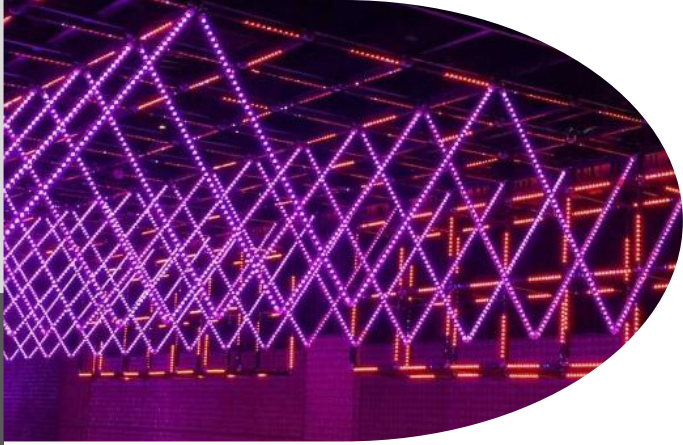

Wiring Diagram

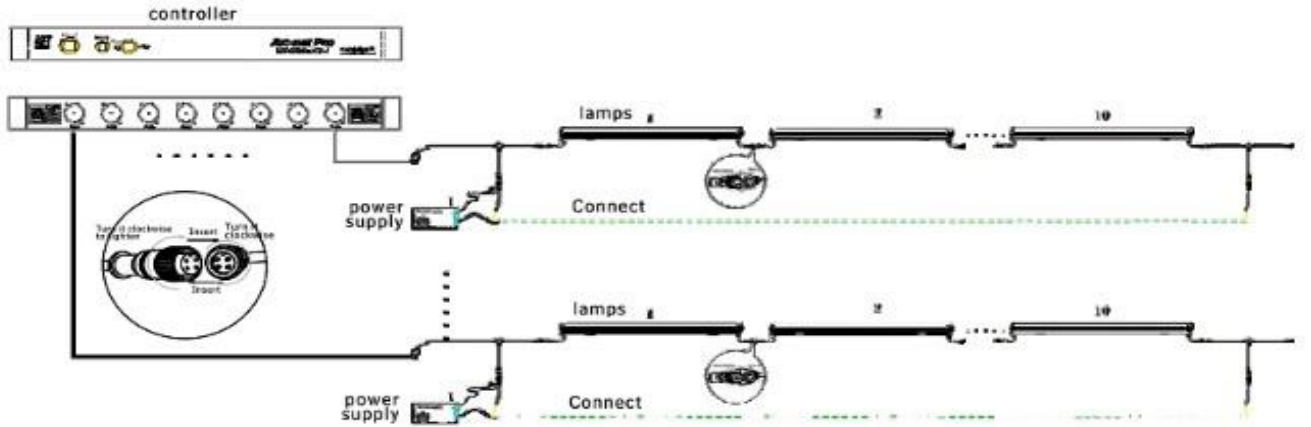

Accessories

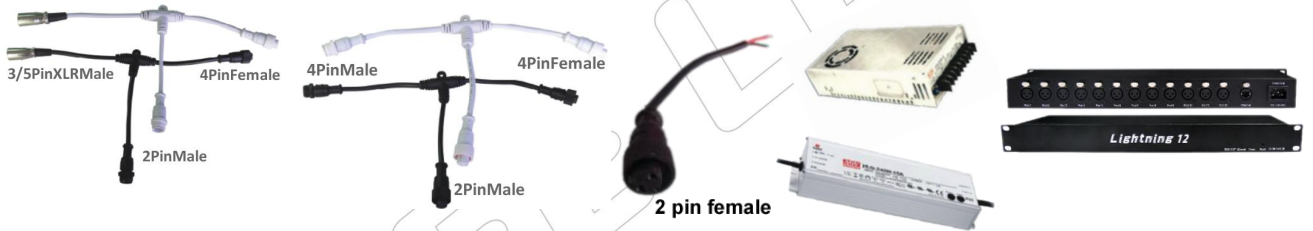

LED-MB 2738 DMX 32 16 - 02 02

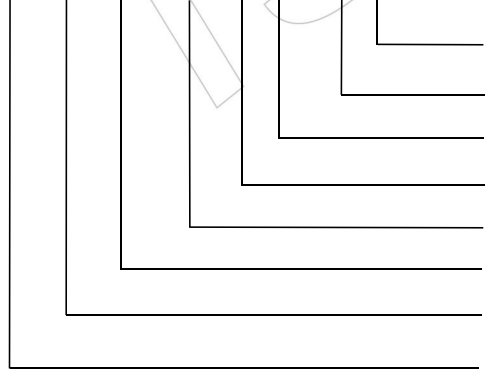

- 01=Cover Color, 01 in milky, 02 in clear, 03 in frosted, 04 in mirror
- 02=Housing Color, 01 in white, 02 in black, 03 in silver
- 16=Pixel Quantity
- 32=LED Quantity
- DMX=Control Protocol
- 2738=width & height (mm)
- MB=Magic Bar
- LED=ISEELED